

ATMOSS[®]
LIGHTING



NEW
PRODUCTS

ENERO 2025



Iluminación



SAMSUNG LED Inside



			°K		Ref	PVPR
Lámpara LED Mini SAMSUNG	G9	2,5W	200Lm	3200K	BLED-423	5,07€
Lámpara LED Mini SAMSUNG	G9	2,5W	200Lm	4200K	BLED-424	5,07€
Lámpara LED Mini SAMSUNG	G9	2,5W	200Lm	5000K	BLED-425	5,07€

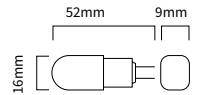

				°K	Ref	PVPR
Lámpara LED Mini SAMSUNG	G9	3W	350Lm	3200K	BLED-426	5,64€
Lámpara LED Mini SAMSUNG	G9	3W	350Lm	4200K	BLED-427	5,64€
Lámpara LED Mini SAMSUNG	G9	3W	350Lm	5000K	BLED-428	5,64€

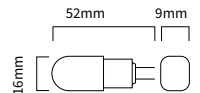

				°K	Ref	PVPR
Lámpara LED Mini SAMSUNG	G9	4W	450Lm	2700K	BLED-453	5,94€
Lámpara LED Mini SAMSUNG	G9	4W	450Lm	3200K	BLED-429	5,94€
Lámpara LED Mini SAMSUNG	G9	4W	450Lm	4200K	BLED-430	5,94€
Lámpara LED Mini SAMSUNG	G9	4W	450Lm	5000K	BLED-431	5,94€

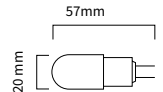

				°K	Ref	PVPR
Lámpara LED Mini SAMSUNG	G9	4W	450Lm	3200K	BLED-435	8,94€
Lámpara LED Mini SAMSUNG	G9	4W	450Lm	4200K	BLED-436	8,94€
Lámpara LED Mini SAMSUNG	G9	4W	450Lm	5000K	BLED-437	8,94€



SOLO REGULACIÓN TRIAC

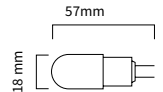

				°K	Ref	PVPR
Lámpara LED Mini SAMSUNG	G9	4W	550Lm	3200K	BLED-432	7,53€
Lámpara LED Mini SAMSUNG	G9	4W	550Lm	4200K	BLED-433	7,53€
Lámpara LED Mini SAMSUNG	G9	4W	550Lm	5000K	BLED-434	7,53€

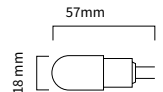

				°K	Ref	PVPR
Lámpara LED Mini SAMSUNG	G9	5W	650Lm	3200K	BLED-438	7,89€
Lámpara LED Mini SAMSUNG	G9	5W	650Lm	4200K	BLED-439	7,89€
Lámpara LED Mini SAMSUNG	G9	5W	650Lm	5000K	BLED-440	7,89€

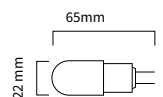



					°K		Ref	PVPR
Lineal LED Mini SAMSUNG		5W	500Lm		2700K		BLED-445	20,88€
Lineal LED Mini SAMSUNG		5W	500Lm		3200K		BLED-446	20,88€
Lineal LED Mini SAMSUNG		5W	500Lm		4200K		BLED-447	20,88€
Lineal LED Mini SAMSUNG		5W	500Lm		5000K		BLED-448	20,88€

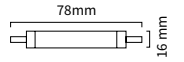

SOLO REGULACIÓN TRIAC



					°K		Ref	PVPR
Lineal LED Mini SAMSUNG		8W	900Lm		2700K		BLED-449	26,22€
Lineal LED Mini SAMSUNG		8W	900Lm		3200K		BLED-450	26,22€
Lineal LED Mini SAMSUNG		8W	900Lm		4200K		BLED-451	26,22€
Lineal LED Mini SAMSUNG		8W	900Lm		5000K		BLED-452	26,22€

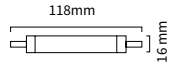

SOLO REGULACIÓN TRIAC

Dicroica 3CCT

IDEAL PARA TECHOS BAJOS

DIFERENTES ESTANCIAS

3 en 1 TRES TIPOS DE LUZ
EN LA MISMA LUMINARIA

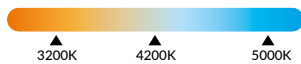

Switch CCT

3200K/4200K/5000K

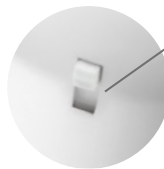

DICROICA LED 7W GU10 3CCT 60°

3CCT

Ref

PVPR

DIC-094

3,96€

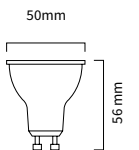

ESPECIAL PARA TECHOS BAJOS

DICROICA LED COMPACTA CON CABLE

3CCT

Ref

PVPR

DIC-095

6,48€

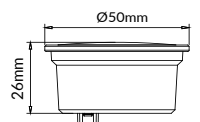



2700K



3000K



4000K

Bombilla standard A60 5CCT

5 en 1 **TRES TIPOS DE LUZ**
EN LA MISMA LUMINARIA

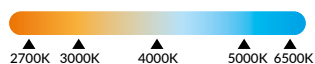

5000K



6500K



	Ref	PVPR
STANDARD A60 E27 11W <i>1100lm 5CCT</i>	BLED-417	4,68€
STANDARD A60 E27 13W <i>1300lm 5CCT</i>	BLED-418	5,64€
STANDARD A60 E27 16W <i>1600lm 5CCT</i>	BLED-419	5,94€

BOMBILLAS PAR30



	K°	Ref	PVPR
PAR30 BLANCO <i>E27 30w 2600lm</i>	3200K	BLED-416	34,62€
PAR30 BLANCO <i>E27 30w 2600lm</i>	4200K	BLED-420	34,62€

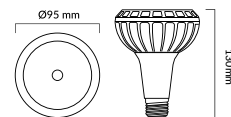

	K°	Ref	PVPR
PAR30 NEGRO <i>E27 30w 2600lm</i>	3200K	BLED-421	34,62€
PAR30 NEGRO <i>E27 30w 2600lm</i>	4200K	BLED-422	34,62€

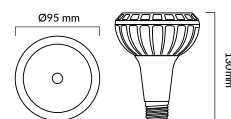



**ESPECIAL
COCINA**

BATERÍA USB

Ref PVPR

REGLETA CON SENSOR DE MOVIMIENTO 40CM

RGL-365 35,07€

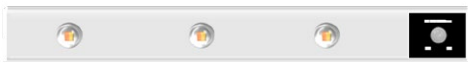

Gran autonomía



Batería - 2000mAh

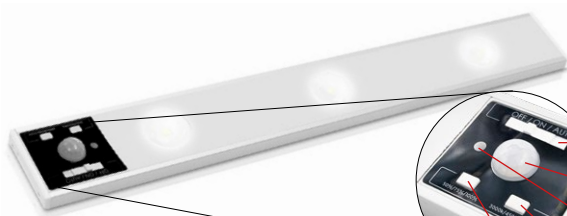

OFF/ON/AUTO

OFF - Apagado
On - Modo continuo de luz
Auto - Modo percepción movimiento

SENSOR PIR

INDICADOR DE CARGA

INTERRUPTOR SELECTOR 3CCT

INTENSIDAD DE LUZ



Tubo led con sensor



BASE G13

TUBO LED RADAR SENSOR 18W 1200mm 160° 5000K TUB-044 15,84€

--	--	--	--	--	--	--	--	--	--

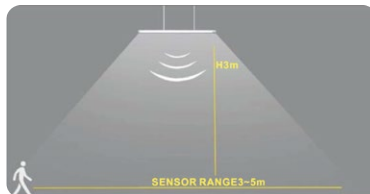

- Distancia detección hasta 5mts
- Altura 3mts
- Tiempo encendido 1min



AJUSTE DE COLORES
Cambia facilmente el color desde el switch

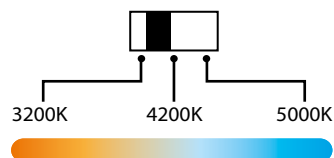

	K°	Ref	PVPR
DOWNLIGHT 3CCT 15W 1200Lm IP40	CCT	DOW-458	21,66€

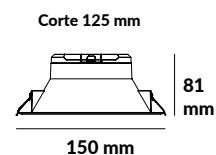



Track light



Ángulo de luz
REGULABLE



ALUMINIO - CONEXIÓN CARRIL TRIFÁSICO - LED INTEGRADO **K°** **Ref** **PVPR**

LED TRACK LIGHT	25w Negro	3200K	TRCK-076	50,52€
LED TRACK LIGHT	25w Negro	4200K	TRCK-075	50,52€
LED TRACK LIGHT	25w Blanco	4200K	TRCK-077	50,52€

25w
2700 Lm
230 v
↓



CARRIL



		Ref	PVPR
BASE SUPERFICIE REDONDO TRIFÁSICO	Blanco	TRCK-071	5,76€
BASE SUPERFICIE REDONDO TRIFÁSICO	Negro	TRCK-072	5,76€



		Ref	PVPR
BASE EMPOTRAR REDONDO TRIFÁSICO	Blanco	TRCK-073	6,48€
BASE EMPOTRAR REDONDO TRIFÁSICO	Negro	TRCK-074	6,48€



Track light empotrado

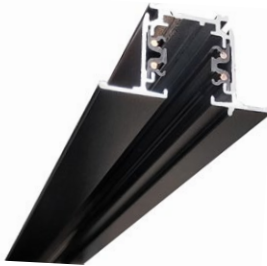

		Ref	PVPR
TRACK RAIL EMPOTRAR 4 HILOS	2Metros Negro	TRCK-083	82,32€
TRACK RAIL EMPOTRAR 4 HILOS	2Metros Blanco	TRCK-084	82,32€
TRACK RAIL EMPOTRAR 4 HILOS	3Metros Negro	TRCK-085	123,45€
TRACK RAIL EMPOTRAR 4 HILOS	3Metros Blanco	TRCK-086	123,45€

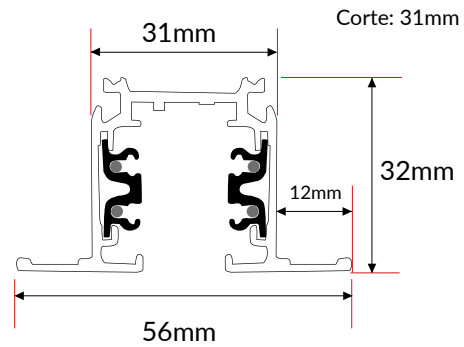
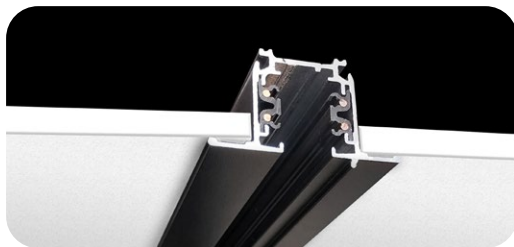

ESQUEMA DE CONEXIÓN TRACK RAIL

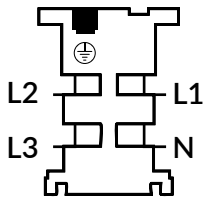

CONECTOR INICIAL
VISTA FRONTAL
NEUTRO DERECHA
TRCK-009/023

VISTA FRONTAL
ORIENTACIÓN
NEUTRO DERECHA
CONEXIÓN CON R

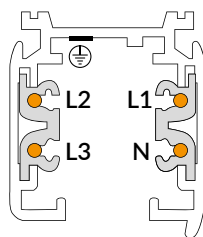

VISTA FRONTAL
ORIENTACIÓN
NEUTRO IZQUIERDA
CONEXIÓN CON L

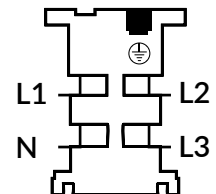
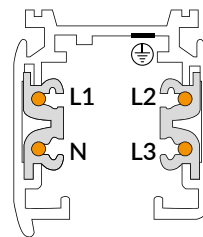

CONECTOR INICIAL
VISTA FRONTAL
NEUTRO IZQUIERDA
TRCK-038/037

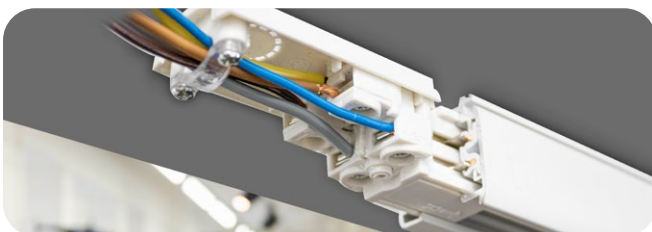

Ejemplo de conexión
con las tres fases.

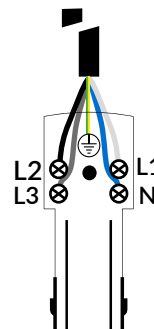

CONECTOR INICIAL
VISTA SUPERIOR
NEUTRO DERECHA
TRCK-009/023

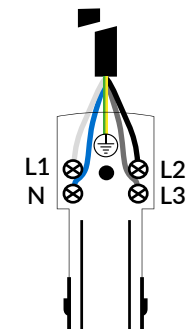

CONECTOR INICIAL
VISTA SUPERIOR
NEUTRO IZQUIERDA
TRCK-038/037

RESPECTAR LA ORIENTACIÓN DEL NEUTRO PARA LA CONEXIÓN.
LAS CONEXIONES ENTRE ACCESORIOS Y TRACK RAIL SE
REALIZARÁN SIEMPRE CONECTANDO "R" CON "L" O VICEVERSA.

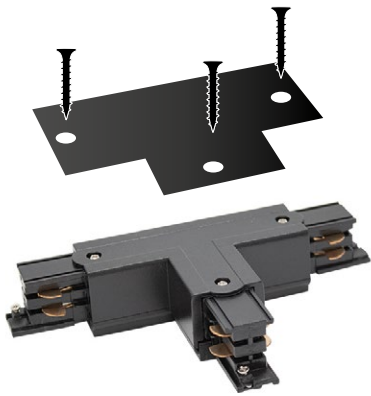

Haz tu instalación empotrada



Se puede adquirir la cubierta para hacer tu instalación empotrada.

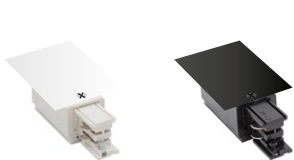

PARA TRCK-009/023 - TRCK-038/037



		Ref	PVPR
CUBIERTA PARA CONECTOR INICIAL	Negro	TRCK-087	1,14€
CUBIERTA PARA CONECTOR INICIAL	Blanco	TRCK-088	1,14€



PARA TRCK-003/017



CUBIERTA PARA TRCK UNION "I"	Negro	TRCK-091	1,86€
CUBIERTA PARA TRCK UNION "I"	Blanco	TRCK-092	1,86€



PARA TRCK-006/020 - 039/040



CUBIERTA PARA TRCK UNION "L"	Negro	TRCK-089	1,86€
CUBIERTA PARA TRCK UNION "L"	Blanco	TRCK-090	1,86€



PARA TRCK-004/018 - 043/046 - 044/047 - 045/048



CUBIERTA PARA TRCK UNION "T"	Negro	TRCK-093	2,25€
CUBIERTA PARA TRCK UNION "T"	Blanco	TRCK-094	2,25€



PARA TRCK-007/021



CUBIERTA PARA TRCK UNION "X"	Negro	TRCK-095	2,61€
CUBIERTA PARA TRCK UNION "X"	Blanco	TRCK-096	2,61€

ACCESORIOS TRACK LIGHT Ficha técnica



	Ref	PVPR
TAPA FINAL PARA RAIL BLANCO	Blanco TRCK-010	1,02€
TAPA FINAL PARA RAIL NEGRO	Negro TRCK-024	1,02€



CONECTOR INICIAL PARA RAIL CON TAPA BLANCO DERECHA	Blanco TRCK-009	7,35€
CONECTOR INICIAL PARA RAIL CON TAPA NEGRO DERECHA	Negro TRCK-023	7,35€



CONECTOR INICIAL PARA RAIL CON TAPA BLANCO IZQUIERDA	Blanco TRCK-038	7,35€
CONECTOR INICIAL PARA RAIL CON TAPA NEGRO IZQUIERDA	Negro TRCK-037	7,35€



UNIÓN "I" PARA RAIL BLANCO	Blanco TRCK-003	12,51€
UNIÓN "I" PARA RAIL NEGRO	Negro TRCK-017	12,51€



UNIÓN "I" INTERIOR PARA RAIL BLANCO	Blanco TRCK-051	7,35€
UNIÓN "I" INTERIOR PARA RAIL NEGRO	Negro TRCK-052	7,35€



UNIÓN "L" PARA RAIL BLANCO DERECHA	Blanco TRCK-006	12,81€
UNIÓN "L" PARA RAIL NEGRO DERECHA	Negro TRCK-020	12,81€



UNION "L" PARA RAIL BLANCO IZQUIERDA	Blanco TRCK-039	12,81€
UNION "L" PARA RAIL NEGRO IZQUIERDA	Negro TRCK-040	12,81€



UNIÓN "T" PARA RAIL BLANCO IZQUIERDA-ARRIBA	Blanco TRCK-004	19,44€
UNIÓN "T" PARA RAIL NEGRO IZQUIERDA-ARRIBA	Negro TRCK-018	19,44€



UNIÓN "T" PARA RAIL BLANCO IZQUIERDA - BAJO	Blanco TRCK-043	19,44€
UNIÓN "T" PARA RAIL NEGRO IZQUIERDA - BAJO	Negro TRCK-046	19,44€

UNIÓN "T" PARA RAIL BLANCO DERECHA - ARRIBA	Blanco TRCK-044	19,44€
UNIÓN "T" PARA RAIL NEGRO DERECHA - ARRIBA	Negro TRCK-047	19,44€

UNIÓN "T" PARA RAIL BLANCO DERECHA - BAJO	Blanco TRCK-045	19,44€
UNIÓN "T" PARA RAIL NEGRO DERECHA - BAJO	Negro TRCK-048	19,44€



UNIÓN "X" PARA RAIL BLANCO DERECHA	Blanco TRCK-007	24,24€
UNIÓN "X" PARA RAIL NEGRO DERECHA	Negro TRCK-021	24,24€



UNIÓN "FLEX" PARA RAIL BLANCO	Blanco TRCK-005	20,97€
UNIÓN "FLEX" PARA RAIL NEGRO	Negro TRCK-019	20,97€



REDONDO

ACCESORIOS SUSPENSIÓN 1 METRO PARA RAIL BLANCO	Blanco TRCK-008	17,28€
ACCESORIOS SUSPENSIÓN 1 METRO PARA RAIL NEGRO	Negro TRCK-022	17,28€

NEW! CUADRADO

ACCESORIOS SUSPENSIÓN 1 METRO PARA RAIL BLANCO	Blanco TRCK-065	6,75€
ACCESORIOS SUSPENSIÓN 1 METRO PARA RAIL NEGRO	Negro TRCK-066	6,75€

Esquema instalación

CONECTOR INICIAL

TRCK-009/023 TRCK-038/037

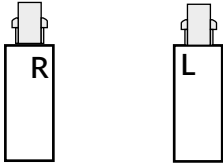

UNIÓN "I"

TRCK-003/017 TRCK-051/052

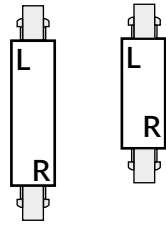

UNIÓN "T"
TRCK-004/018

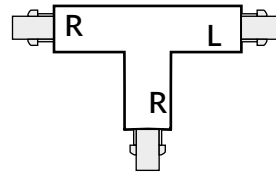

UNIÓN "T"
TRCK-043/046

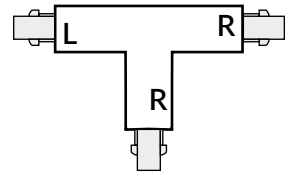

UNIÓN "T"
TRCK-044/047

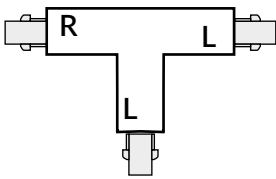

UNIÓN "T"
TRCK-045/048

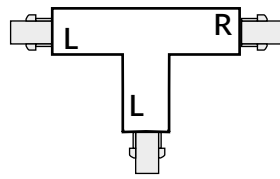

UNIÓN "L"
TRCK-006/040

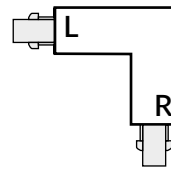

UNIÓN "L"
TRCK-039/020

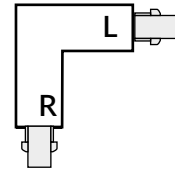

UNIÓN "X"
TRCK-007/021

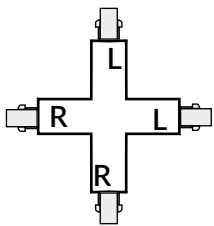

UNIÓN "FLEX"
TRCK-005/019



EJEMPLO INSTALACIÓN

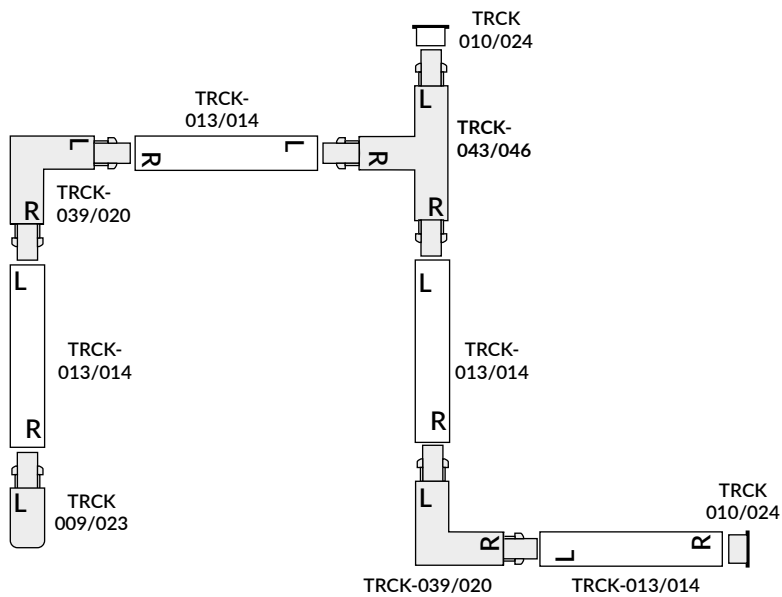



Apliques

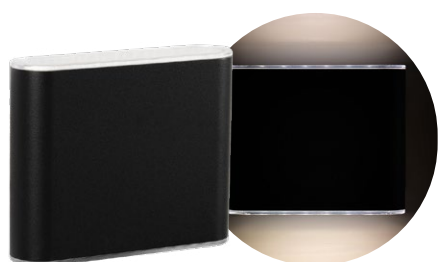

* Led incluido

SERIE ALUMINIO

APLIQUE EXTERIOR ALUMINIO 3CCT **6W** **3CCT** **APQ-470** **37,86 €**

6w
800 Lm
180°
230 v
IP 65
↓



115 mm



90 mm

48 mm

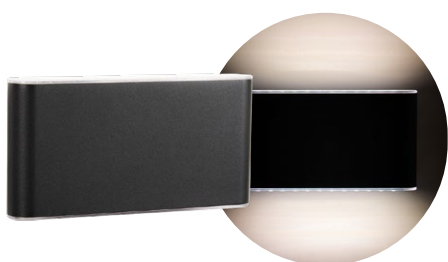

* Led incluido

SERIE ALUMINIO

APLIQUE EXTERIOR ALUMINIO 3CCT **12W** **3CCT** **APQ-471** **40,20 €**

12w
1500 Lm
180°
230 v
IP 65
↓



175 mm



90 mm

48 mm



* Led incluido

SERIE ALUMINIO

			K°	Ref	PVPR
APLIQUE EXTERIOR CUADRADO ALUMINIO	Negro	6W	3CCT	APQ-474	36,36 €
APLIQUE EXTERIOR CUADRADO ALUMINIO	Blanco	6W	3CCT	APQ-475	36,36 €

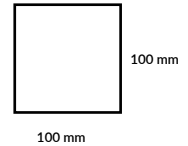

* Led incluido

SERIE ALUMINIO

			K°	Ref	PVPR
APLIQUE EXTERIOR OVAL ALUMINIO	Negro	6W	3CCT	APQ-472	39,54 €
APLIQUE EXTERIOR OVAL ALUMINIO	Blanco	6W	3CCT	APQ-473	39,54 €

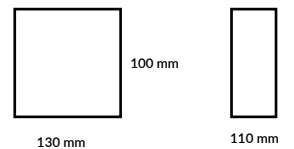



Apliques Exterior

IP 65



3 en 1 TRES TIPOS DE LUZ EN LA MISMA LUMINARIA

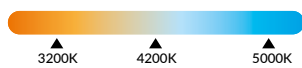

* Led incluido **SERIE PLASTIC**

	K°	Ref	PVPR
APLIQUE LED REDONDO	Gris - 15W CCT	APQ-486	20,22 €
APLIQUE LED CUADRADO	Gris - 15W CCT	APQ-487	20,22 €

15w
1500 Lm
100°
230 v
IP 65
20

3CCT

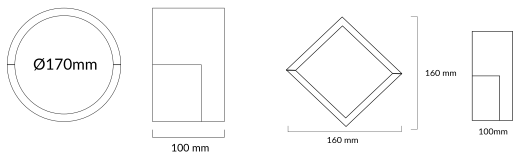

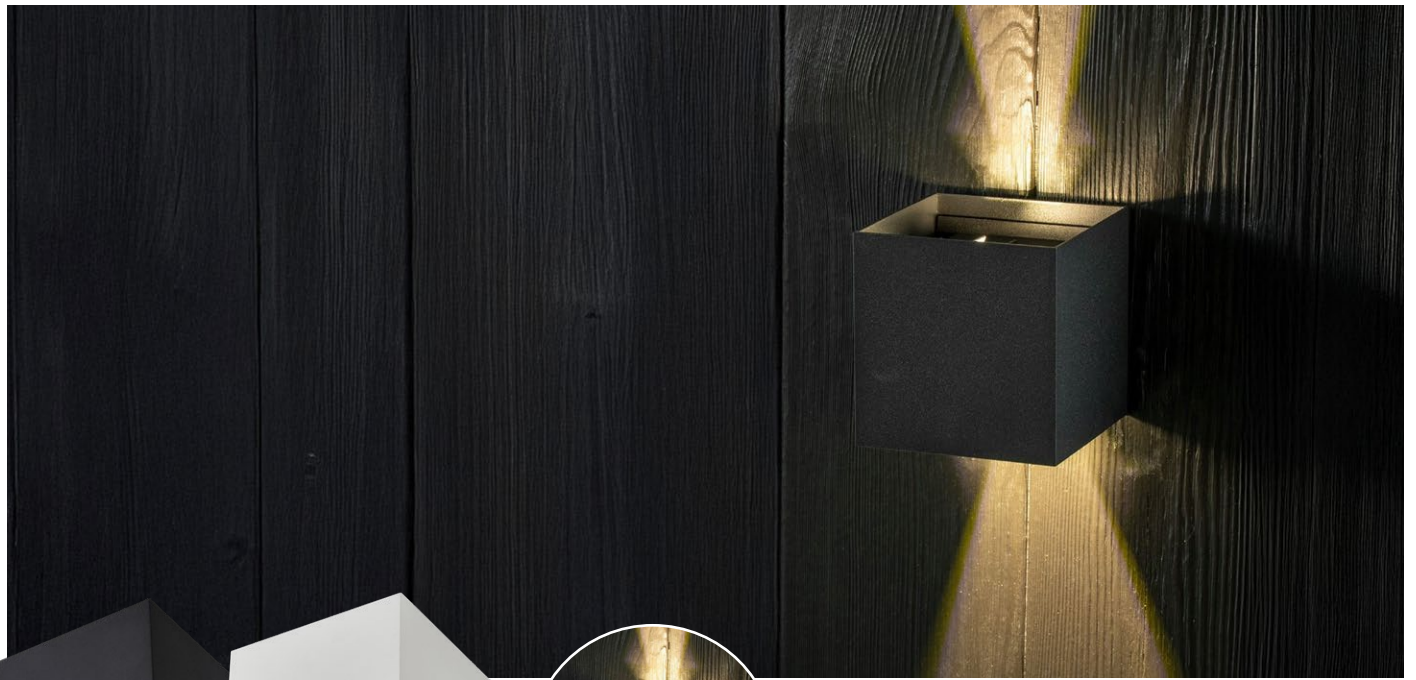

* Led NO INCLUIDO - Incluye portalámparas

SERIE ALUMINIO

		Ref	PVPR
APLIQUE EXTERIOR CUADRADO ALUMINIO	Negro MÁX 4W	APQ-476	27,60€
APLIQUE EXTERIOR CUADRADO ALUMINIO	Blanco MÁX 4W	APQ-477	27,60€

Aplique para Bombilla G9
(Bombilla no incluida)

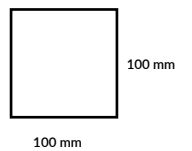

* Led NO INCLUIDO - Incluye portalámparas

SERIE ALUMINIO

		Ref	PVPR
APLIQUE EXTERIOR OVAL ALUMINIO	Negro MÁX 6W	APQ-478	26,82€
APLIQUE EXTERIOR OVAL ALUMINIO	Blanco MÁX 6W	APQ-479	26,82€

Aplique para Bombilla G9
(Bombilla no incluida)

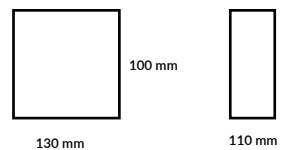

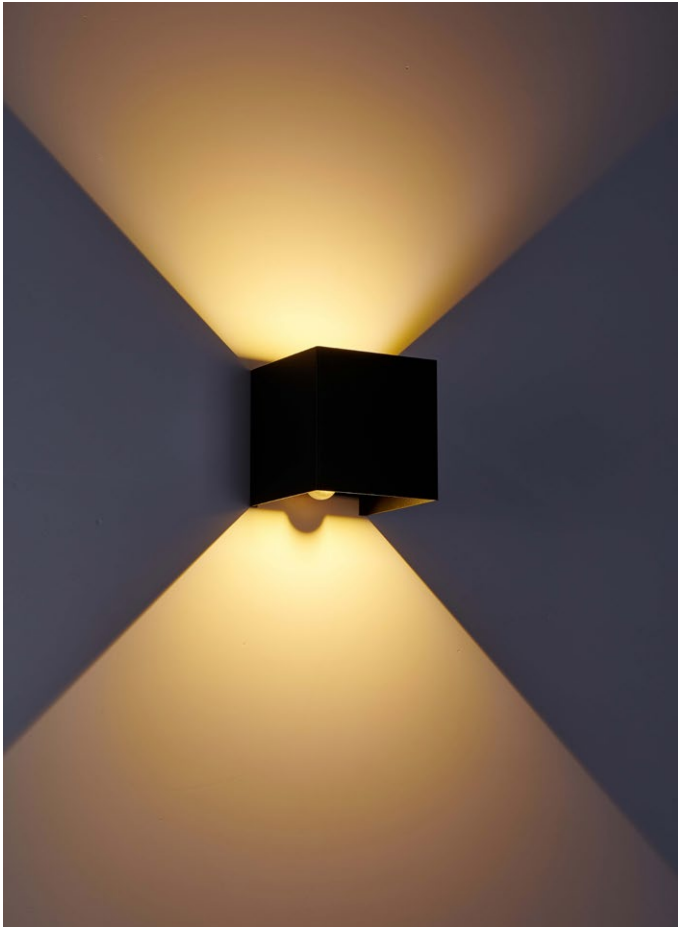

LED INCLUIDO

SERIE ALUMINIO

APLIQUE LED EXTERIOR CUADRADO

Negro

10W

3200K



Ref APQ-488

PVPR

31,62€

10w

1000 Lm

230 v

IP 65

SENSOR PIR MOVIMIENTO



SENSOR CREPUSCULAR

- Distancia detección 3 mts
- Tiempo encendido 30-40 seg

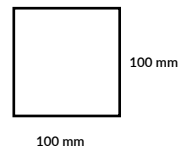

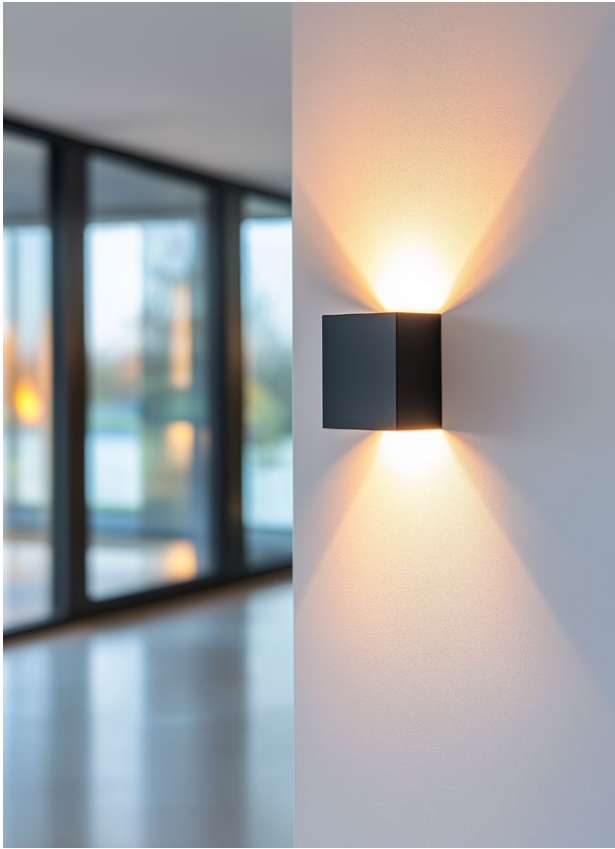

LED INCLUIDO

SERIE ALUMINIO

				Ref	PVPR
APLIQUE LED INTERIOR CUADRADO	Negro	6W	3200K	APQ-501	16,80€
APLIQUE LED INTERIOR CUADRADO	Negro	6W	5000K	APQ-502	16,80€

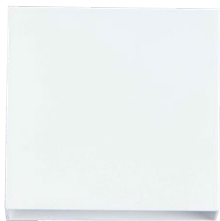
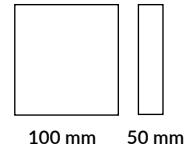
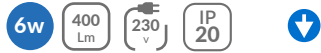

LED INCLUIDO

SERIE ALUMINIO

				Ref	PVPR
APLIQUE LED INTERIOR CUADRADO	Blanco	6W	3200K	APQ-503	16,80€
APLIQUE LED INTERIOR CUADRADO	Blanco	6W	5000K	APQ-504	16,80€

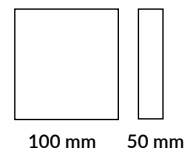

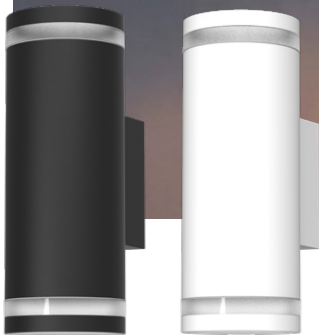
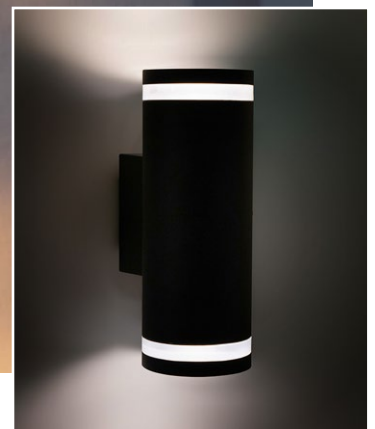

* Led **NO INCLUIDO** - Incluye portalámparas

SERIE ALUMINIO

			Ref	PVPR
APLIQUE EXTERIOR CIRCULAR ANILLO	<i>Negro</i>	<i>MÁX 7W</i>	APQ-480	35,52€
APLIQUE EXTERIOR CIRCULAR ANILLO	<i>Blanco</i>	<i>MÁX 7W</i>	APQ-481	35,52€

Aplique para Bombilla GU10
(Bombilla no incluida)

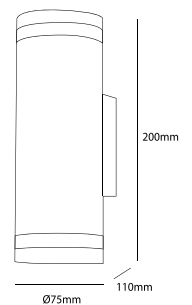



* Led **NO INCLUIDO** - Incluye portalámparas

SERIE ALUMINIO

Ref PVPR

APLIQUE EXTERIOR RECTANGULAR ANILLO	Negro	MÁX 7W	APQ-482	27,90€
APLIQUE EXTERIOR RECTANGULAR ANILLO	Blanco	MÁX 7W	APQ-483	27,90€

Aplique para Bombilla GU10
(Bombilla no incluida)

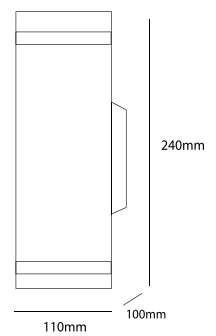



Apliques de escalera



LED INCLUIDO

SERIE ALUMINIO

APLIQUE LED EXTERIOR EMPOTRADO

Negro

3W

2700K



APQ-506

23,40€

Ref

PVPR

3w

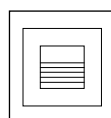

57 mm



35 mm

Cubierta protectora
Corte: 48x48x46mm



48 mm

48 mm



46 mm



LED INCLUIDO

SERIE ALUMINIO

					Ref	PVPR
APLIQUE LED EXTERIOR REDONDO	Negro	3W	3200K	●	APQ-489	23,76€
APLIQUE LED EXTERIOR REDONDO	Negro	3W	4200K	●	APQ-490	23,76€

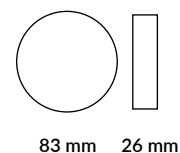

LED INCLUIDO

SERIE ALUMINIO

					Ref	PVPR
APLIQUE LED EXTERIOR REDONDO	Negro	3W	3200K	●	APQ-491	32,34€
APLIQUE LED EXTERIOR REDONDO	Negro	3W	4200K	●	APQ-492	32,34€



- Distancia detección 3 mts
- Tiempo encendido 30-40 seg

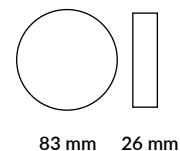

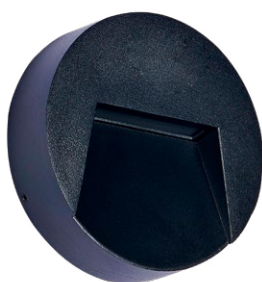

LED INCLUIDO

SERIE ALUMINIO

					Ref	PVPR
APLIQUE LED EXTERIOR REDONDO	Negro	3W	3200K	●	APQ-493	25,95€
APLIQUE LED EXTERIOR REDONDO	Negro	3W	4200K	●	APQ-494	25,95€

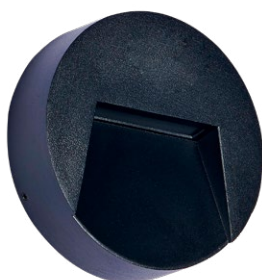
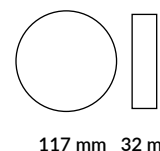

LED INCLUIDO

SERIE ALUMINIO

					Ref	PVPR
APLIQUE LED EXTERIOR REDONDO	Negro	3W	3200K	●	APQ-495	34,50€
APLIQUE LED EXTERIOR REDONDO	Negro	3W	4200K	●	APQ-496	34,50€



- Distancia detección 3 mts
- Tiempo encendido 30-40 seg

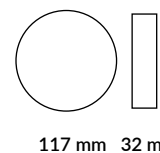



LED INCLUIDO

SERIE ALUMINIO

					Ref	PVPR
APLIQUE LED EXTERIOR CUADRADO	Negro	3-5W	2700K	●	APQ-505	27,75€
APLIQUE LED EXTERIOR CUADRADO	Negro	3-5W	3200K	●	APQ-497	27,75€
APLIQUE LED EXTERIOR CUADRADO	Negro	3-5W	4200K	●	APQ-498	27,75€

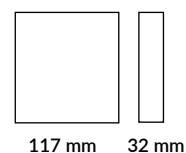

LED INCLUIDO

SERIE ALUMINIO

					Ref	PVPR
APLIQUE LED EXTERIOR CUADRADO	Negro	3-5W	3200K	●	APQ-499	36,24€
APLIQUE LED EXTERIOR CUADRADO	Negro	3-5W	4200K	●	APQ-500	36,24€



- Distancia detección 3 mts
- Tiempo encendido 30-40 seg

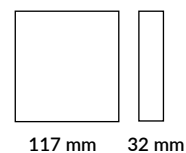



SERIE ALUMINIO

PANEL-CRISTAL

LÁMPARA DE PIE CON PANEL DE CRISTAL

Negro MÁX 28W

Ref PVPR

APQ-485 47,82€

Lámpara para Bombilla E27
(Bombilla no incluida)



SERIE ALUMINIO

PANEL-CRISTAL

APLIQUE DE PARED CON PANEL DE CRISTAL

Negro MÁX 28W

Ref PVPR

APQ-484 40,92€

Lámpara para Bombilla E27
(Bombilla no incluida)





Gama Solar

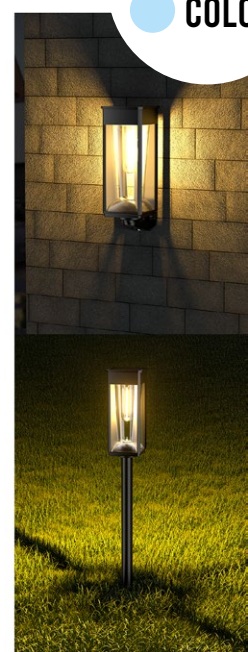

Incluido Acc de pared y suelo

SERIE PLASTIC

LED INCLUIDO

APLIQUE SOLAR PARED/SUELO
DUAL COLOR 3200K / 5000K

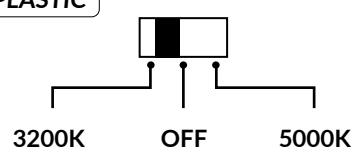

Ref	PVPR
APQ-076	26,85€

- IP 65
- Batería 3.7V 600mAh
- Panel solar - 5V 80mA
- Gran autonomía
- Carga solar 6-8Hrs





BATERÍA: 3.7V 1500mAh

SERIE PLASTIC

Ref

PVPR

APLIQUE LED SOLAR PARED 2 DIRECCIONES

IP65

3200K



APQ-071

23,28€



IP 65

150 Lm



Ángulo de luz AJUSTABLE



BATERÍA: 3.7V 1500mAh

SERIE PLASTIC

Ref

PVPR

APLIQUE LED SOLAR PARED 2 DIRECCIONES

IP65

3200K/5000K



APQ-072

24,54€



IP 65

100 Lm



Ángulo de luz AJUSTABLE



DUAL COLOR



3200K
5000K



BATERÍA: 3.7V 1500mAh

SERIE PLASTIC

Ref

PVPR

LÁMPARA LED SOLAR PARED 5000K

IP65

5000K



APQ-073

12,90€



IP 65

150 Lm



SENSOR MOVIMIENTO



SOLAR VINTAGE



BATERÍA: 3.7V 2000mAh - 2 FORMAS DE COLOCACIÓN (PARED - SUELO)

Ref PVPR

APLIQUE LED SOLAR PARED PIRAMIDE NEGRO

IP65

5000K

APQ-074

59,40€



IP 44

100 Lm



SERIE ALUMINIO



PANEL-VIDRIO



BATERÍA: 3.7V 1500mAh

SERIE PLASTIC

Ref PVPR

APLIQUE LED SOLAR PARED PIRAMIDE NEGRO

IP65

5000K

APQ-075

11,28€



IP 65

250 Lm

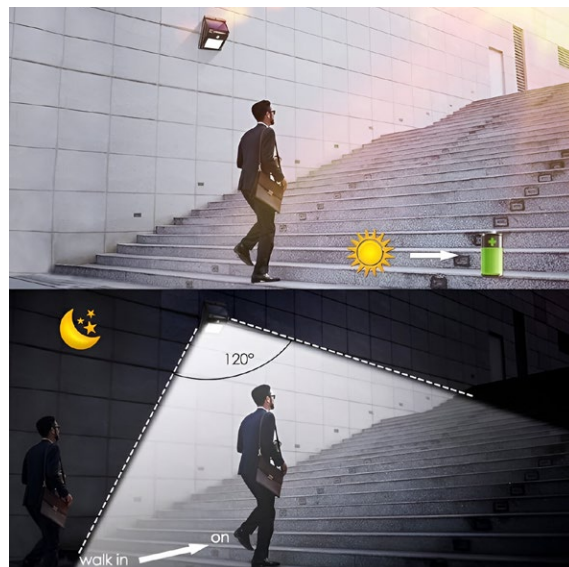



- 
CARGA SOLAR
- 
CONTROL INTELIGENTE DE LUZ
- 
RESISTENTE AL AGUA
- 
SENSOR PIR DE MOVIMIENTO

		K	Ref	PVPR
FAROLA LED SOLAR 50MM DIAM C/MANDO		1100Lm LED IP65	5000K	FRL-046 154,71€

- 1100 Lm
- 1
- IP 65
- 360°
-  **SENSOR PIR MOVIMIENTO**
- 

Disponible control remoto

-  **SENSOR CREPUSCULAR**



		K	Ref	PVPR
FAROLA LED SOLAR 50MM DIAM C/MANDO		2100Lm LED IP65	5000K	FRL-047 225,60€

- 2100 Lm
- 1
- IP 65
- 360°
-  **SENSOR PIR MOVIMIENTO**
- 

Disponible control remoto

-  **SENSOR CREPUSCULAR**



		Ref	PVPR
SOPORTE PARA FAROLA SOLAR FRL-046/047		ACLED-492	15,54€



Lit by
LUMILEDS

SERIE ALUMINIO

		K°	Ref	PVPR
FAROLA LED SOLAR 48MM DIAM C/MANDO	1800Lm LED IP65	3200K	FRL-056	185,40€
FAROLA LED SOLAR 48MM DIAM C/MANDO	1800Lm LED IP65	4200K	FRL-048	185,40€
FAROLA LED SOLAR 48MM DIAM C/MANDO	1800Lm LED IP65	5000K	FRL-049	185,40€

1800 Lm

1

IP 65

150°

SENSOR PIR MOVIMIENTO



SENSOR CREPUSCULAR

Disponible control remoto



Lit by
LUMILEDS

SERIE ALUMINIO

		K°	Ref	PVPR
FAROLA LED SOLAR 48MM DIAM C/MANDO	2600Lm LED IP65	3200K	FRL-057	224,55€
FAROLA LED SOLAR 48MM DIAM C/MANDO	2600Lm LED IP65	4200K	FRL-050	224,55€
FAROLA LED SOLAR 48MM DIAM C/MANDO	2600Lm LED IP65	5000K	FRL-051	224,55€

2600 Lm

1

IP 65

150°

SENSOR PIR MOVIMIENTO



SENSOR CREPUSCULAR

Disponible control remoto



Lit by
LUMILEDS

SERIE ALUMINIO

		K°	Ref	PVPR
FAROLA LED SOLAR 48MM DIAM C/MANDO	3400Lm LED IP65	3200K	FRL-058	289,08€
FAROLA LED SOLAR 48MM DIAM C/MANDO	3400Lm LED IP65	4200K	FRL-052	289,08€
FAROLA LED SOLAR 48MM DIAM C/MANDO	3400Lm LED IP65	5000K	FRL-053	289,08€

3400 Lm

1

IP 65

150°

SENSOR PIR MOVIMIENTO



SENSOR CREPUSCULAR

Disponible control remoto



Ø BASE 48mm

		Ref	PVPR
SOPORTE PARA FAROLA SOLAR FRL-048/053	GRIS	ACLED-493	

Disponible control remoto



BATERIA LiFeP04 3.2V 20Ah
LARGA DURACION CLASE A

NEW FAROLA UFO

NUEVO DISEÑO | NUEVA BATERÍA

- BATERÍA MEJORADA
- MEJORA ESTÉTICA
- ALTA LUMINOSIDAD
- MAYOR AUTONOMÍA

Ø BASE 50mm - SENSOR DE MOVIMIENTO Y CREPUSCULAR

		Kº	Ref	PVPR
FAROLA LED SOLAR 50MM DIAM C/MANDO	1800Lm LED IP65	3200K	FRL-054	215,70€
FAROLA LED SOLAR 50MM DIAM C/MANDO	1800Lm LED IP65	5000K	FRL-055	215,70€

1800 Lm

1

IP 65

360º

SENSOR PIR MOVIMIENTO



TEMPORIZADOR



CONTROL DE LUZ INTELIGENTE



MANDO A DISTANCIA



SENSOR DE MOVIMIENTO PIR



Tiras de Led



TIRA LED COB 5W/M



TIRA LED COB *5w/m IP20*

K° Ref PVPR
3200K ● TLED-134 55,92€

5 w/m 480 Lm/m 24V 1 120° IP 20 5 M SLIM 4mm MUEBLES



5m

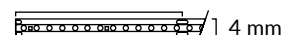

TIRA LED COB 12W/M IP65



TIRA LED COB *12w/m IP65*

K° Ref PVPR
2700K ● TLED-130 46,62€

12 w/m 1140 Lm/m 24V 1 120° IP 65 5 M

Adhesivo posterior 3M VHB EXTRA FUERTE



5m

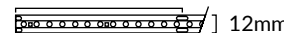

TIRA LED COB *12w/m IP65*

K° Ref PVPR
3200K ● TLED-131 533,22€

12 w/m 1140 Lm/m 24V 1 120° IP 65 50 M

Adhesivo posterior 3M VHB EXTRA FUERTE



50m

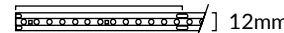

TIRA LED COB *12w/m IP65*

K° Ref PVPR
2700K ● TLED-140 48,48€

12 w/m 1140 Lm/m 24V 1 120° IP 65 5 M

Protección silicona BLANCO MATE
Adhesivo posterior 3M VHB EXTRA FUERTE



5m

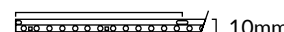

TIRA LED COB *12w/m IP65*

K° Ref PVPR
2700K ● TLED-136 484,74€

12 w/m 1140 Lm/m 24V 1 120° IP 65 50 M

Protección silicona BLANCO MATE
Adhesivo posterior 3M VHB EXTRA FUERTE



50m

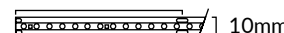

CONEXIÓN DIRECTA 230V



TIRA LED COB *12w/m IP65*

K° Ref PVPR
2700K ● TLED-126 596,64€

12 w/m 960 Lm/m 230V 1 120° IP 65 50 M

Adhesivo posterior 3M VHB EXTRA FUERTE



50m



ACCESORIOS PARA TLED 126-127-128-129



Ref ACLED - 494
Enchufe
conexión

PVPR 7,08€



ACLED - 495
Cable 1 metro
sin enchufe

8,94€



ACLED - 496
Conector COB
Tira-Tira recto

1,86€



ACLED - 497
Conector COB
Tira-Tira esquina

2,61€



ACLED - 498
Tapa final
12mm

0,36€

ACCESORIOS PARA TLED 136-137-138-139-140-141-142-143



Ref ACLED - 502
Conector Cob
Tira-Cable
300mm

PVPR 4,86€



ACLED - 503
Conector Cob
Tira-Tira recto

1,86€



ACLED - 504
Conector Cob
Tira-Tira esquina

2,61€



ACLED - 505
Conector COB
Tapa final

0,36€

ACCESORIOS PARA TLED 130-131-132-133



Ref ACLED - 257
Conector Cob
Tira-Cable
300mm

PVPR



ACLED - 158
Tapa final para
Tira led

0,54€

ACCESORIOS PARA TLED 134



Ref ACLED - 252
Conector Cob
Tira-Cable
4mm



ACLED - 253
Conector Cob
Tira-Tira 4mm



ACLED - 254
Conector Cob
Tira-Tira c/cable
4mm



Tiras de Led digital

TIRA LED DIGITAL 10W/M



TIRA LED DIGITAL

10w/m IP65

DIGITAL RGB

TLED-135

PVPR

67,08€

5m

Corte cada 10cm

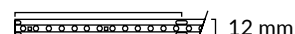

10 w/m

400 Lm/m

24V

1

120°

IP 65

5 M



Adhesivo posterior
3M VHB EXTRA FUERTE



CONTROLADOR LED 8A

RGB/RGBW DIGITAL SPI

CONTR-100

Ref

PVPR

73,32€



Personaliza completamente una gran cantidad de modos de color RGB / RGBW



INSTRUCCIONES

VIDEO INSTALACIÓN

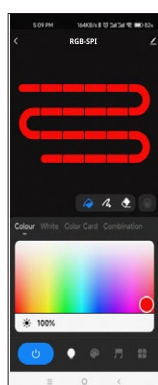

Color

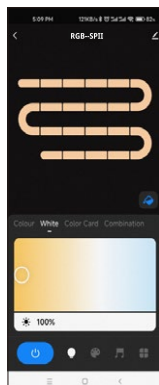

Blanco

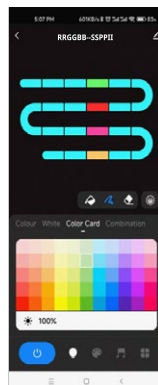

Carta de colores

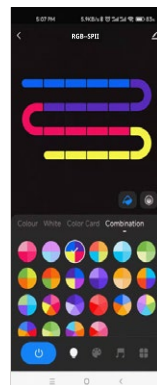

Combinación



PARA TIRA LED DIGITAL - Pilas CR2032 -

MANDO NEGRO CONTROLADOR RF

RGB / RGBW

Ref

CONTR-101

PVPR

48,24€



ZONA RGB o RGBW



Tira de led Neon Flex



Corte cada 10cm

TIRA LED NEON FLEX 230V

3200K

Ref

PVPR

TLED-122

178,32€



Corte cada 10cm

TIRA LED NEON FLEX 230V

4200K

Ref

PVPR

TLED-123

178,32€



Corte cada 10cm

TIRA LED NEON FLEX 230V

6500K

Ref

PVPR

TLED-124

178,32€



Corte cada 10cm

TIRA LED NEON FLEX 230V

Golden

Ref

PVPR

TLED-125

178,32€



ACCESORIOS

TLED-122/123/124/125



Ref

PVPR

ENCHUFE CONEXIÓN TIRA LED NEON FLEX

ACLED-487

3,48€



TAPA FINAL PARA TIRA LED NEON FLEX

ACLED-488

0,39€



NO DISPONE DE WIFI

PASTILLA PULSADOR CON EFECTO MEMORIA - FUNCIONA PARA VARIOS PULSADORES -

PASTILLA **DIMMABLE TRIAC** POR PULSADOR **MÁX 360W** CONTR-022 52,62€



CONTR-036 CONTR-098

COMPATIBLE CON MANDO
CONTR-036 Y CONTR-098

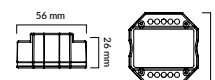

Disponible
para varios
pulsadores



PASTILLA **DIMMABLE TRIAC** WIFI 300W LED **WIFI 300W LED** CONTR-063 60,66€

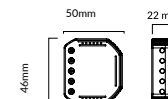

CONTROLADOR **DIMMABLE TRIAC** WIFI PULSADOR **WIFI 500W LED** CONTR-096 84,30€



- CONEXIÓN WIFI, 2,4GHz, BLUETOOTH
- CONTROL REMOTO 2,4GHz
- DIMMABLE 0-100% SIN PARPADEO

MANDO CONTROL REMOTO

PARA TLED MONOCOLOR Y DUAL COLOR

PARA CONTR-038 Y CONTR-022

RUEDA TÁCTIL - Pilas x2 AAA

Ref PVPR

MANDO RF 4 ZONAS 3 ESCENAS **MONO / CCT** CONTR-098 64,26€



4 ZONAS - 3 ESCENAS



PARA TLED RGB Y RGBW

PARA CONTR-039

RUEDA TÁCTIL - Pilas x2 AAA

Ref PVPR

MANDO RF 1 ZONAS 2 ESCENAS **RGB / RGBW** CONTR-099 64,26€



1 ZONA - 2 ESCENAS



Domotiza tu vivienda a la mejor **calidad precio** **SENCILLO Y EFICAZ**



Algunos de nuestros productos son
Compatibles con los principales asistentes de voz
(asistente de Google*, Amazon*, Alexa* ... etc.)”v

Estas marcas son propiedad de sus respectivos propietarios,
y como tal, son reconocidas por Atmoss Electric Equipment S.L
y son utilizadas únicamente con fines enunciativos.

App
tuya

HAZ TU VIDA MÁS FÁCIL Y SEGURA

DOMOTIZA TODO TU HOGAR CON PRODUCTOS DE ATMOS

Seguridad



Cámaras

Sensores

Persianas



Pastilla interruptor de persianas.



Mando, Pulsador, interruptor de persianas

Enchufes



Interruptor wifi. Corte fase y neutro



Enchufe WiFi

Iluminación



Lámparas WiFi



Pastilla regulador Triac WiFi



Controlador Tiras de led



Proyector WiFi

Puerta garaje



Pastilla interruptor puerta de garaje.



Pulsador de persianas

Domótica



Tuya Smart es la **aplicación más utilizada** en el sector del hogar inteligente.

Su funcionamiento está basado en la gestión de dispositivos inteligentes, proporcionando un control total y remoto, además de configurar escenarios predeterminados que aumentan la usabilidad y calidad de la APP.

SEGURIDAD

Se trata de la configuración de una red de seguridad compuesta por **alarmas, detectores, cerradura inteligente, cámaras...** Permite controlar cualquier tipo de intrusión mediante cámaras de vigilancia o alarmas personales.

PERSIANAS

Controla tu persiana mediante smartphone, mando, pulsador,...

ENCHUFES

La mejor forma de **controlar el encendido y apagado de dispositivos** conectados a la electricidad. Puede monitorizar el **ahorro de energía**, proteger contra sobretensiones, desconectar la alimentación de la red eléctrica **mediante tu smartphone**.

PUERTA GARAJE

Automatiza tu puerta del garaje, abre tu puerta sin necesidad de bajar del vehículo.

ILUMINACIÓN

Crea diferentes ambientes con nuestras lámparas WiFi. Controla el encendido o apagado, la regulación o el color desde la App.

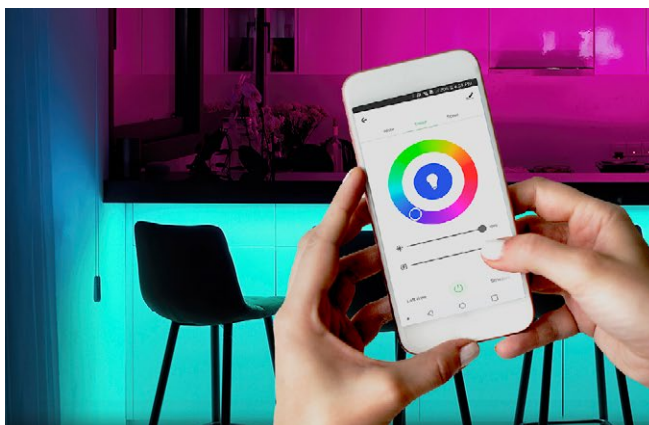

VENTAJAS

- Ayuda para personas con movilidad reducida.
- Ahorro energético.
- Mejor confort.
- Fácil instalación.
- Domotiza tu vivienda a un precio reducido.
- Amplía la cobertura WiFi en tu vivienda.

NUEVA CÁMARA

4.0MP
MEGAPIXEL



IP66

COMPATIBLE
CON APP **tuya**

CAM-009



ALTA RESOLUCIÓN

2K
QUADHD



2K - BLANCA - VISIÓN NOCTURNA EN COLOR - MOTORIZADA

	Ref	PVPR
CAMARA WIFI VIGILANCIA 2K 4MP IP66	CAM-009	119,70€

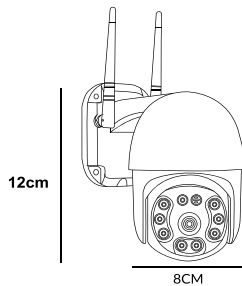



Control de acceso



	Ref	PVPR
TECLADO CONTROL NUMÉRICO ACCESO PUERTA APP TUYA	SGR-041	104,85€



- Admite 2000 usuarios
- Velocidad de funcionamiento rápida, <20ms con 2000 usuarios
- Admite tarjeta, PIN, tarjeta+PIN
- Teclas retroiluminadas
- Tiempo de apertura de puerta ajustables
- Protección contra cortocircuitos
- Fácil de instalar y programar



	Ref	PVPR
FUENTE DE ALIMENTACIÓN 12V	SGR-042	48,45€



	Ref	PVPR
TIMBRE 12V ABS SONIDO DING DONG BLANCO	TIMB-399	18,30€



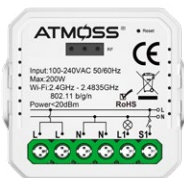

Compatible con CONTR-105

Ref PVPR

PASTILLA REGULACIÓN TRIAC WIFI RF UART HOLE

CONTR-104 58,50€



Sensores



SENSOR PRESENCIA

Altura de instalación: 2,5m - 4m

Señal de movimiento máxima de 4-5m (radio) (Movimiento de la mano, movimiento de la cabeza)
Señal de respiración de 2-3 m (radio).- 12min

SENSOR DE PRESENCIA EMPOTRADO **360° 400W LED IP65** Ref ACLED-485 PVPR 79,86€

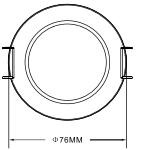
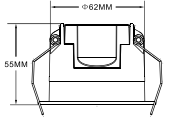

Altura de instalación 2 - 2,5m

Distancia de DETECCIÓN REGULABLE 1,2 - 4,6m

SENSOR DE PRESENCIA SUPERFICIE **360° 1000W LED IP65** Ref ACLED-486 PVPR 63,42€



Altura de instalación 2 - 2,5m

Distancia de DETECCIÓN REGULABLE 1,2,4,6m

Lux regulable 10/30/100 lux

10 seg - 15min

SENSOR DE PRESENCIA SUPERFICIE/EMPOTRADO **360° 400W LED IP20** Ref ACLED-491 PVPR 77,46€



Altura de instalación 1 - 1,8m

Distancia de DETECCIÓN 9m

SENSOR DE MOVIMIENTO INFRARROJO PARED EMPOTRADO **160° 200W LED IP20** Ref ACLED-482 PVPR 26,76€



Altura de instalación 1,8 - 4m

Distancia de DETECCIÓN 8m

SENSOR DE MOVIMIENTO INFRARROJO EMPOTRADO **360° 600W LED IP65** Ref ACLED-470 PVPR 17,07€

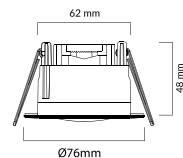



Altura de instalación 1,8 - 2,5m
 Distancia de DETECCIÓN 12m

		Ref	PVPR
SENSOR DE MOVIMIENTO INFRARROJO SUPERFICIE	180°/360° 600W LED IP65	ACLED-471	25,62€



Altura de instalación 1,8 - 2,5m
 Distancia de DETECCIÓN 12m

		Ref	PVPR
SENSOR DE MOVIMIENTO INFRARROJO EXTERIOR SUPERFICIE	180-360° 300W LED IP65	ACLED-483	24,66€



Altura de instalación: 1,8 - 2,5mts
 Distancia detección Ø12mts

		Ref	PVPR
SENSOR DE MOVIMIENTO INFRARROJO	180° 300W LED IP44	ACLED-479	14,10€

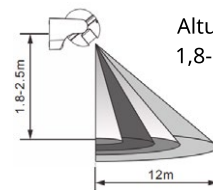

Altura de instalación:
 1,8-2,5m



Altura de instalación:
 Montaje en pared de 1,8 a 2,5 m
 Montaje en techo de 2,2-4 m
 Velocidad de movimiento de detección: 0,6-1,5 m/s
SENSOR 3 EN 1 PARED / TECHO / ESQUINA

		Ref	PVPR
SENSOR DE MOVIMIENTO INFRARROJO SUPERFICIE	180-360° 1000W LED IP54	ACLED-481	35,22€



INFORMACIÓN DEL SENSOR:

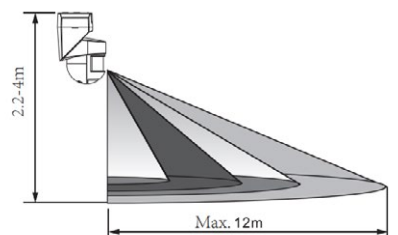
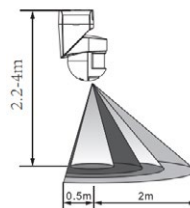
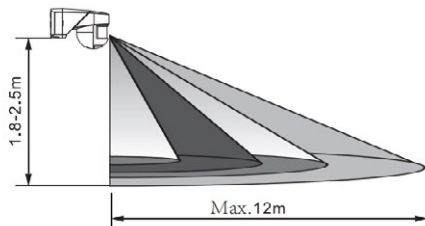
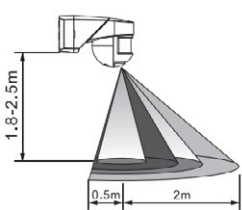



Sensor caja estanco



Altura de instalación 1 - 1,8m
Distancia de DETECCIÓN 10m

SENSOR DE MOVIMIENTO ESTANCO 190° 500W LED IP65

Ref ACLED-478 PVPR 31,65€



INCLUYE MANDO

Altura de instalación 1 - 1,8m
Distancia de DETECCIÓN 10m

SENSOR DE MOVIMIENTO INFRARROJO CAJA ESTANCA 180-360° 1000W LED IP65

Ref ACLED-484 PVPR 42,30€



Altura de instalación 2,2 - 4m
Distancia de DETECCIÓN 8m

SENSOR DE MOVIMIENTO INFRARROJO SUPERFICIE/EMPOTRAR 360° 600W LED IP20

Ref ACLED-472 PVPR 18,84€



Altura de instalación: 2,2 - 4mts
Distancia detección Ø8mts

SENSOR DE MOVIMIENTO INFRARROJO EMPOTRADO 360° 300W LED IP20

Ref ACLED-480 PVPR 19,02€

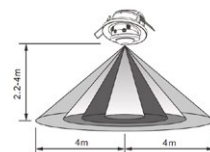

Altura de instalación:
2,2 - 4mts



Sensor de mano



Distancia de DETECCIÓN 5-6cm

SENSOR DE ON/OFF MOVIMIENTO MANO 360° 500W LED IP20

Ref	PVPR
ACLED-473	17,43€



ON/OFF
SENSOR DE
MOVIMIENTO
MANO



Sensor de puerta



Distancia de DETECCIÓN 5-6cm

SENSOR DE ON/OFF MOVIMIENTO PUERTA 360° 500W LED IP20

Ref	PVPR
ACLED-474	17,43€



ON/OFF
SENSOR DE
MOVIMIENTO
PUERTA



Sensor de escalera

CONTROLADORES SENSOR DE ESCALERA

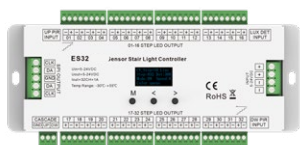

CONTROLADOR LUZ ESCALERA CON SENSOR PIR

Ref	PVPR
CONTR-102	283,20€



[INSTRUCCIONES](#)



[VIDEO INSTALACIÓN](#)

Incluye:

- PIR Sensor 2Ud (1,2mts)
- Sensor de luz diurna
- Cable sensor PIR (5mts)

- Número de luces de escalera ajustable, máx. 32 peldaños
- 8 velocidades de iluminación graduadas ajustables
- 4 modos de iluminación de trabajo opcionales
- Dos controladores de luz de escalera pueden funcionar en cascada
- Control de interruptor pulsador opcional

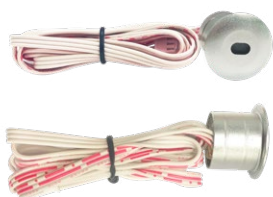

CABEZAL SENSOR DE MOVIMIENTO PIR

Ref	PVPR
CONTR-103	26,82€

Dynamic ART S40

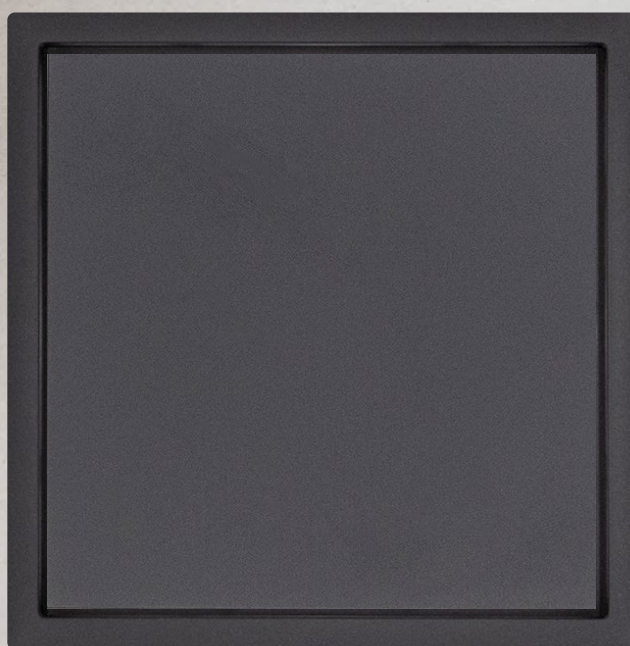



Dynamic Art



	Ref	PVPR
TAPA BASE 16A USB TIPO A,C/ BLANCO S40 ART	S40.408.10	2,92€



	Ref	PVPR
TAPA BASE 16A USB TIPO A,C/ ALUMINIO S40 ART	S40.408.11	4,28€



	Ref	PVPR
TAPA BASE 16A USB TIPO A,C/ NEGRO S40 ART	S40.408.17	4,28€



	Ref	PVPR
TECLA PULSADOR ESCALERA CON LED BLANCO S40 ART	S40.409.10	1,84€



	Ref	PVPR
TECLA PULSADOR ESCALERA CON LED ALUMINIO S40 ART	S40.409.11	2,84€



	Ref	PVPR
TECLA PULSADOR ESCALERA CON LED NEGRO S40 ART	S40.409.17	2,84€



	Ref	PVPR
TAPA SALIDA CABLE/BLANCO MATE S40 ART	S40.419.18	1,28€



Interruptor tarjeta



8800 W - TIEMPO 20s - Válido para cajas universales

		REF	PVPR
INTERRUPTOR DE TARJETA	Blanco	SGR-044	11,88€
INTERRUPTOR DE TARJETA	Negro	SGR-045	11,88€





ATMOSS
ELECTRIC

Aparamenta y accesorios



MATERIAL
ELÉCTRICO

AHORRA ESPACIO, hasta un 50% más en tú instalación
con los nuevos modelos de espacio reducido

EJEMPLO DE INSTALACIÓN DE VIVIENDA DE 50 A 20CM

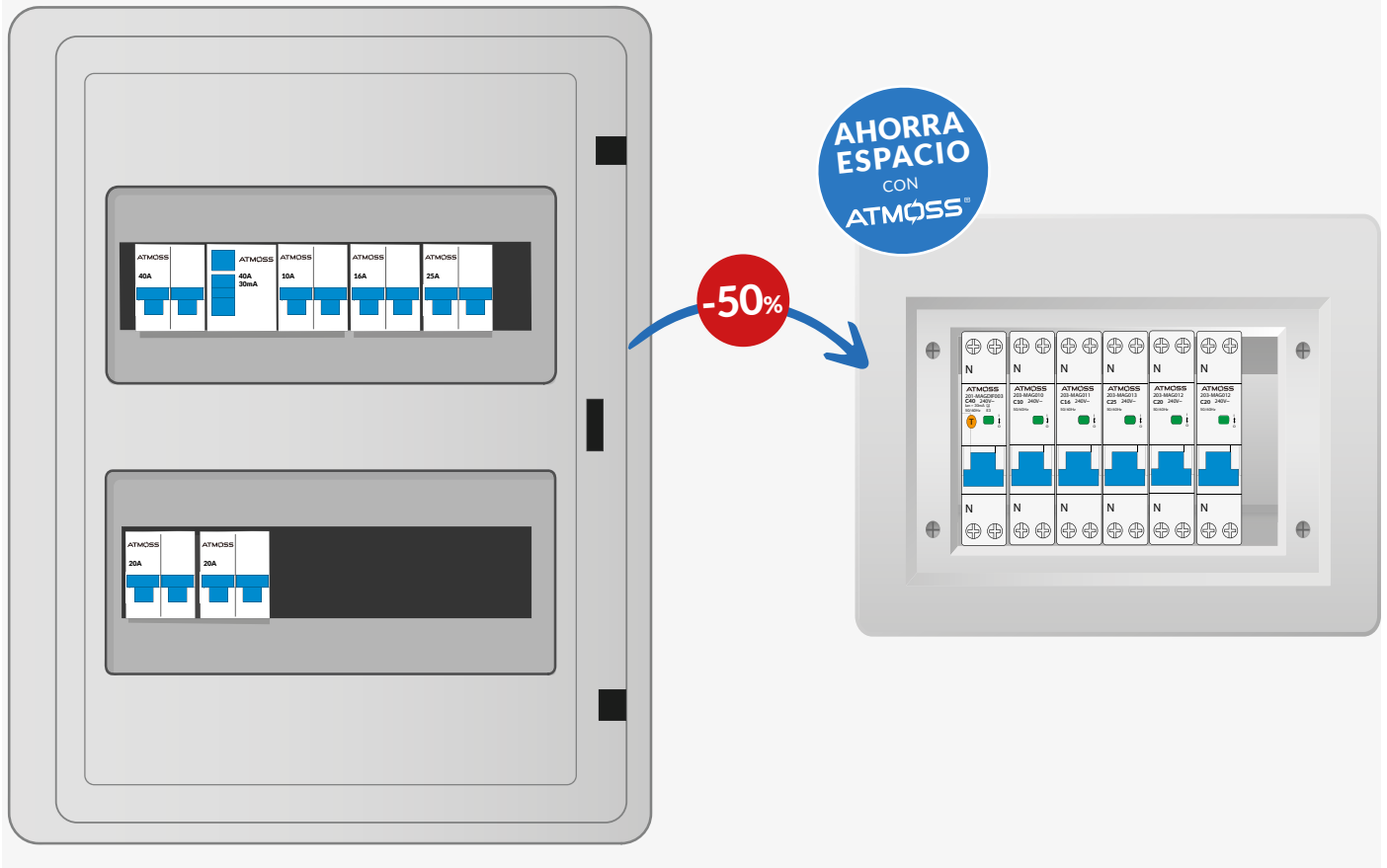

Ejemplo de instalación de vivienda:



MAGNETOTÉRMICO GENERAL
2P 40A - 6kA - Curva C
200-MAG028



Magnetotérmico general + Diferencial
1P+N 40A - 6kA 30mA
Curva C
201-MAGDIF003



DIFERENCIAL
2P 40A - 6kA - TIPO AC
200-DIF011

PEQUEÑO INTERRUPTOR AUTOMÁTICO PIAS



- 200-MAG023 -10A
- 200-MAG024 -16A
- 200-MAG026 -25A
- 200-MAG025 -20A



- 203-MAG010 -10A
- 203-MAG011 -16A
- 203-MAG013 -25A
- 203-MAG012 -20A



Diferencial 2P - 10kA - Tipo AC 

2P - 10kA - 30mA - 63A

REF		PVPR
100-DIF005	63A 10kA 30mA	43,86 €



4 POLOS - 10kA - TIPO AC   1 UDS

REF		PVPR
101-DIF00003	63A 10kA 300mA	57,93 €

Evita los cortes intempestivos 
MAYOR SENSIBILIDAD



Diferencial Superinmunizados

4 POLOS - 10kA - TIPO A   1 UDS

REF		PVPR
100-DIF015	63A 10kA 300mA	67,98 €
100-DIF022	100A 10kA 300mA	81,78 €

SERIES COMBI VIGI

SERIE COMBI

**2POLOS EN
1 MÓDULO**

Magneto Diferencial Superinmunizado Tipo A 

REF		PVPR
301-MGDIF000	10A 6kA 10mA	62,55 €

IP+N - 6kA 30mA - Curva C

301-MGDIF001	10A 6kA	62,55 €
301-MGDIF002	16A 6kA	62,55 €
301-MGDIF003	20A 6kA	62,55 €
301-MGDIF004	25A 6kA	62,55 €
301-MGDIF005	32A 6kA	62,55 €
301-MGDIF006	40A 6kA	62,55 €

IP+N - 6kA 300mA - Curva C

301-MGDIF008	16A 6kA	62,55 €
301-MGDIF012	40A 6kA	62,55 €





Compatible con pila CR2032
Módulo estrecho 1 módulo

INTERRUPTOR HORARIO DIGITAL

Programa tus dispositivos eléctricos con facilidad.

Es adecuado para uso particular de las siguientes tareas:

- Iluminación de áreas privadas e industriales,
- Iluminación de calles y escaparates
- Regulación de aire acondicionado
- Motores, bombas, plantas y maquinaria, así como para simular presencia, etc.

- Interruptor de disparo externo
- Programa de cuenta atrás (1s~59m59s)
- Programa diario y semanal.
- 32 programas de pulso (1s~59m59s)
- Fecha y hora preestablecidas
- 16 grupos de programa ON/OFF
- Mostrar año/mes/día/hora/minuto
- Encendido/Apagado permanente
- Totalmente operable sin conexión a la red eléctrica
- Reemplazo de batería de litio y batería recargable

	REF		PVPR	
INTERRUPTOR HORARIO DIGITAL	RLJ-013	16A 230V IP20	55,50€	↓

Cintas eléctricas

USO PROFESIONAL



20m
x19mm (Ancho)
0,15mm Grosor

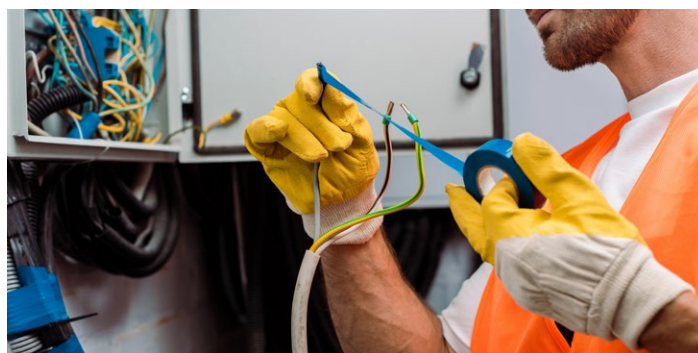
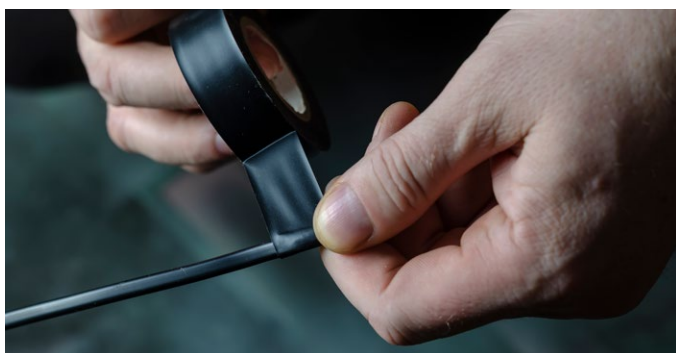

CINTAS ELÉCTRICAS DE PRIMERA CALIDAD PARA AISLAMIENTO ELÉCTRICO

Norma: EN 60454-3-12:2006 NORMA CE 2014/35/EU



CARACTERÍSTICAS

- Alta flexibilidad.
- Alta resistencia a la rotura.
- Alta recuperación de elasticidad
- Ignífugo
- Buena protección mecánica y eléctrica
- Aislamiento de hilos y cables eléctricos hasta 600v, 80°C
- Espesor 0,15mm
- Composición, cinta de PVC con adhesivo de caucho

DESCARGAR 
FICHA TÉCNICA

Medidas  20mm  19mm · 0,15mm



SE VENDE EN PAQUETE DE 10UDS - PRECIO UNITARIO

 10 UDS Ref PVPR

CINTA AISLANTE PVC IGNÍFUGO **NEGRO** CIN-001 1,44€



SE VENDE EN PAQUETE DE 10UDS - PRECIO UNITARIO

 10 UDS Ref PVPR

CINTA AISLANTE PVC IGNÍFUGO **AZUL** CIN-002 1,44€



SE VENDE EN PAQUETE DE 10UDS - PRECIO UNITARIO

 10 UDS

Ref

PVPR

CINTA AISLANTE PVC IGNÍFUGO

AMARILLO-VERDE

CIN-003

1,44€



SE VENDE EN PAQUETE DE 10UDS - PRECIO UNITARIO

 10 UDS

Ref

PVPR

CINTA AISLANTE PVC IGNÍFUGO

BLANCO

CIN-004

1,44€



SE VENDE EN PAQUETE DE 10UDS - PRECIO UNITARIO

 10 UDS

Ref

PVPR

CINTA AISLANTE PVC IGNÍFUGO

VERDE

CIN-005

1,44€



SE VENDE EN PAQUETE DE 10UDS - PRECIO UNITARIO

 10 UDS

Ref

PVPR

CINTA AISLANTE PVC IGNÍFUGO

GRIS

CIN-006

1,44€



SE VENDE EN PAQUETE DE 10UDS - PRECIO UNITARIO

 10 UDS

Ref

PVPR

CINTA AISLANTE PVC IGNÍFUGO

ROJO

CIN-007

1,44€



SE VENDE EN PAQUETE DE 10UDS - PRECIO UNITARIO

 10 UDS

Ref

PVPR

CINTA AISLANTE PVC IGNÍFUGO

AMARILLO

CIN-008

1,44€



Reloj temporizador

NEW!



Reloj temporizador digital

RLJ-011

Reloj temporizador semanal digital

PVPR 28,59 €

 1 UDS

DESCARGAR 
VIDEO

NEW!



Reloj temporizador exterior IP44

RLJ-012

Reloj temporizador mecánico blanco exterior

PVPR 19,74 €

 1 UDS



NEW!



Reloj temporizador

RLJ-010

Reloj temporizador mecánico mini blanco

PVPR 14,22 €

 1 UDS



Portalámpara E27



PORTALÁMPARA E27	BLANCO	PORTLM-004	0,78€
PORTALÁMPARA E27	NEGRO	PORTLM-005	0,78€



Timbres



				Ref	PVPR
TIMBRE BUZZER	30W	220V-240V	SONIDO ZUMBADOR	TIMB-004	5,55€





ATMOSS[®]

LIGHTING



Atmoss Electric Equipment, S.L.
Calle los Mecánicos, 5 03130
Pol. Ind. Santa Pola (Alicante) España

Tel. +34 966 693 404 / +34 865 66 48 50

www.atmoss.es